

2x

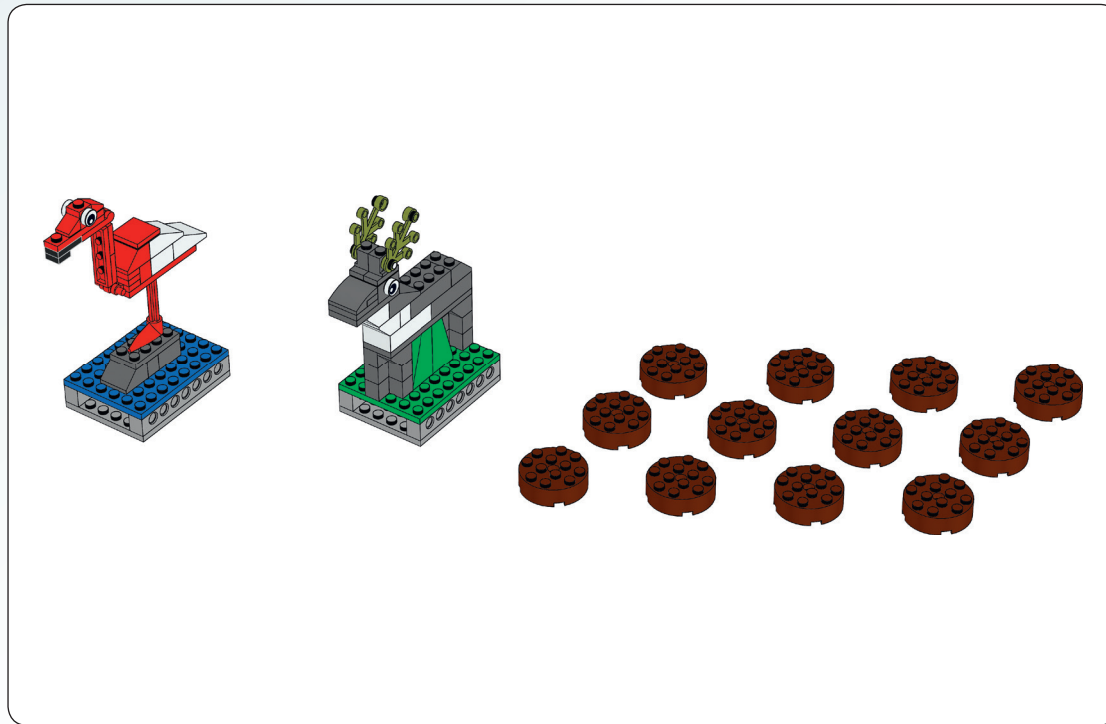



12x



12x

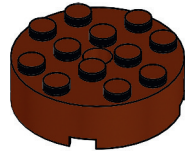

12x

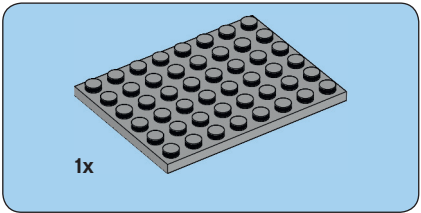
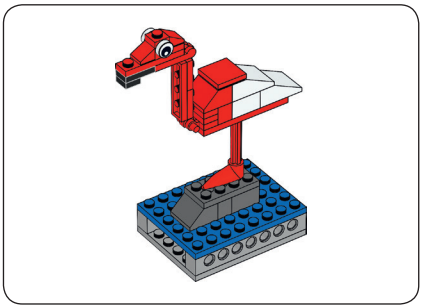

1x

1

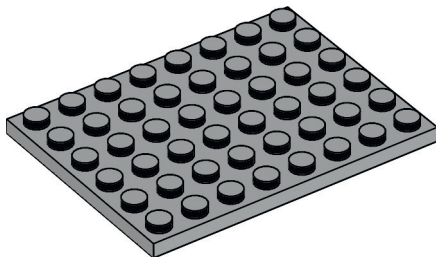

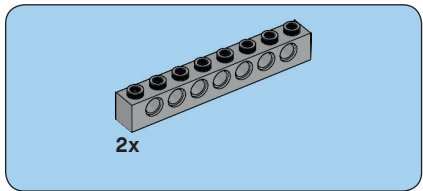

2

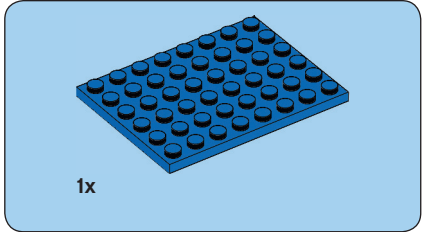
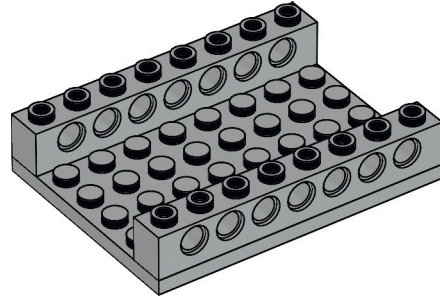

3

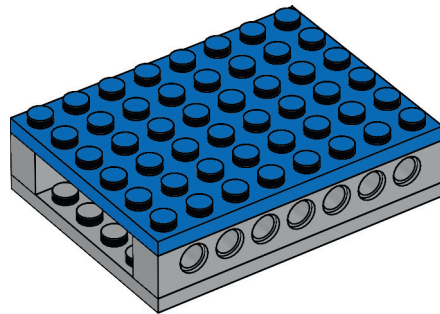

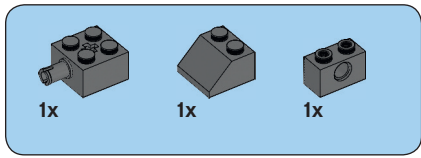

4

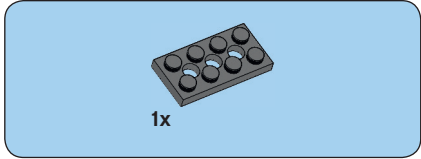
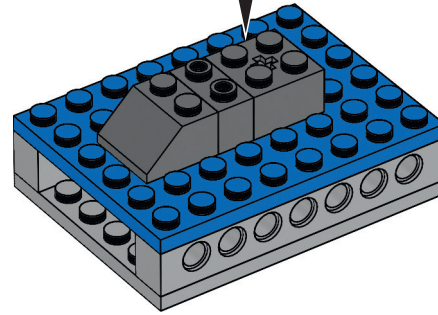
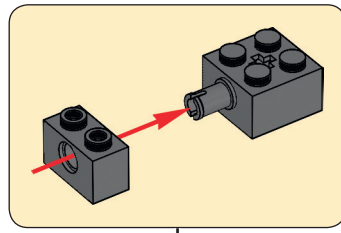

5

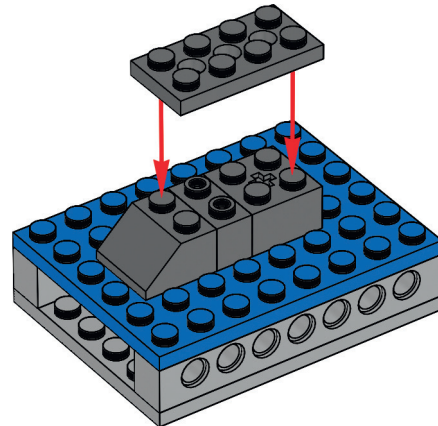

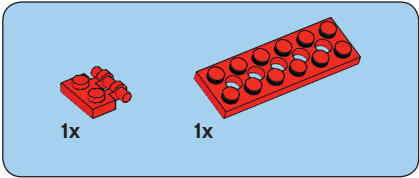
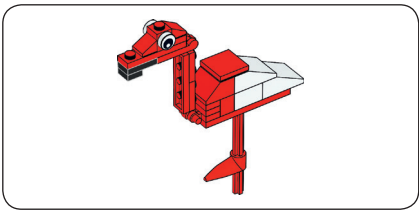

6

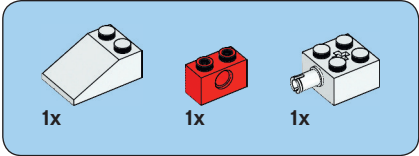
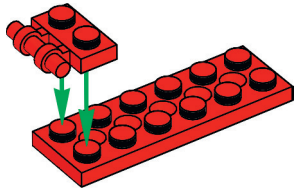

7

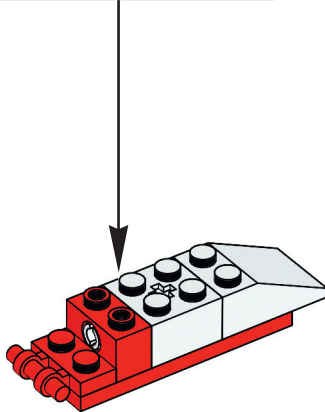
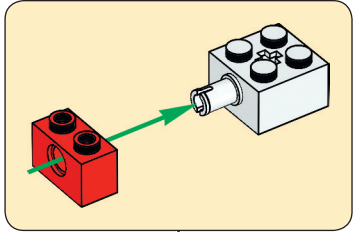

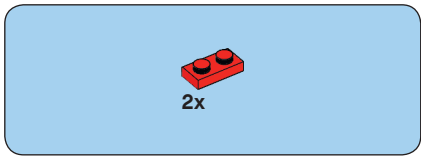

8

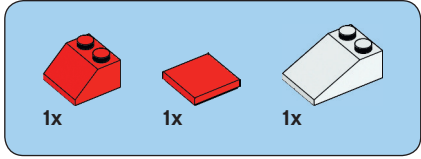
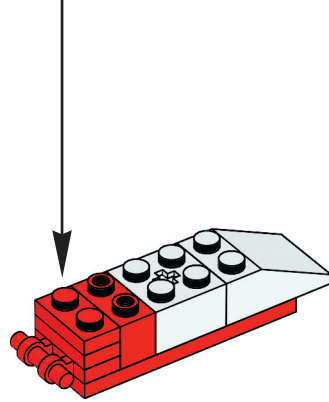
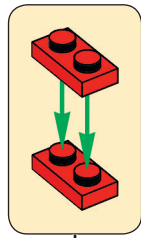

9

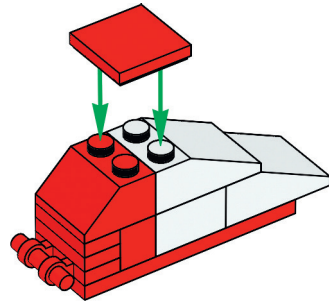

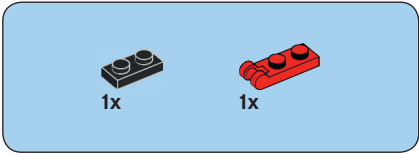
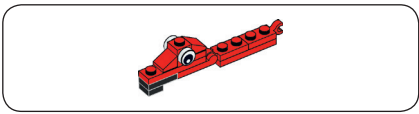

10

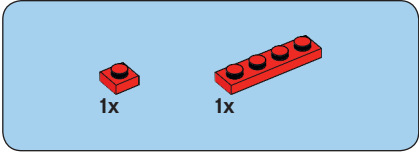
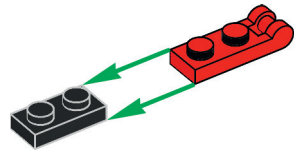

11

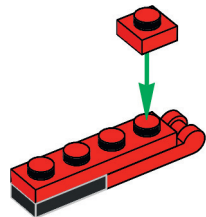

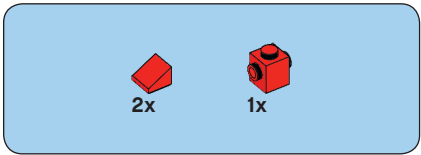

12

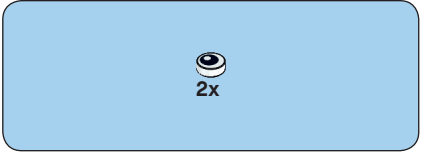
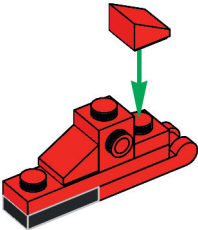

13

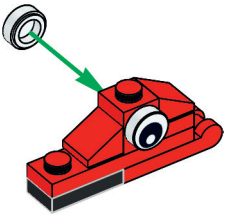

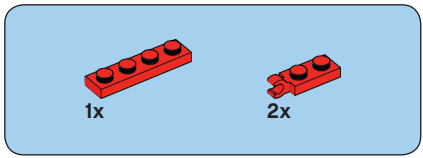

14

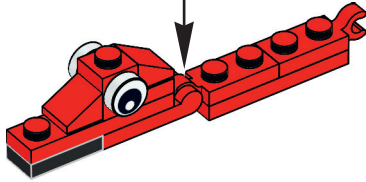
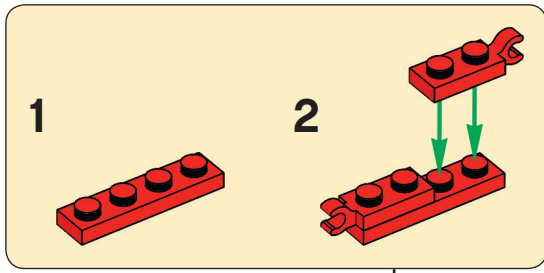

15

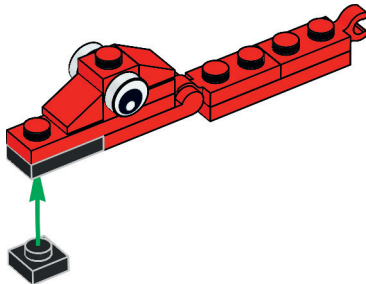

16

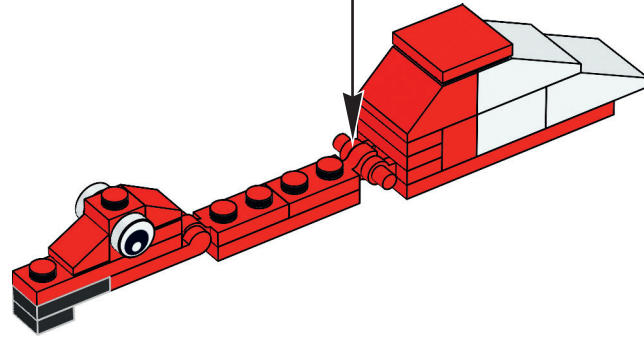

17

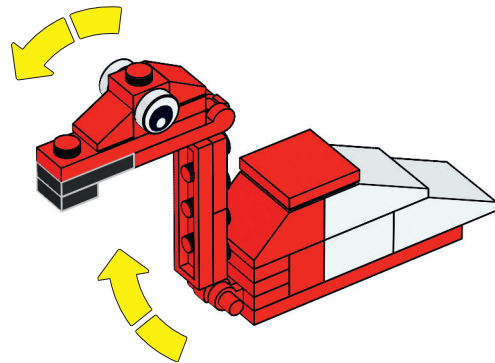

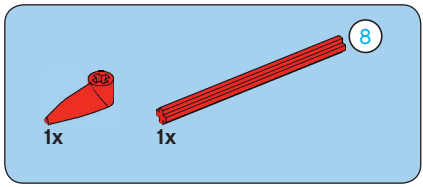

18

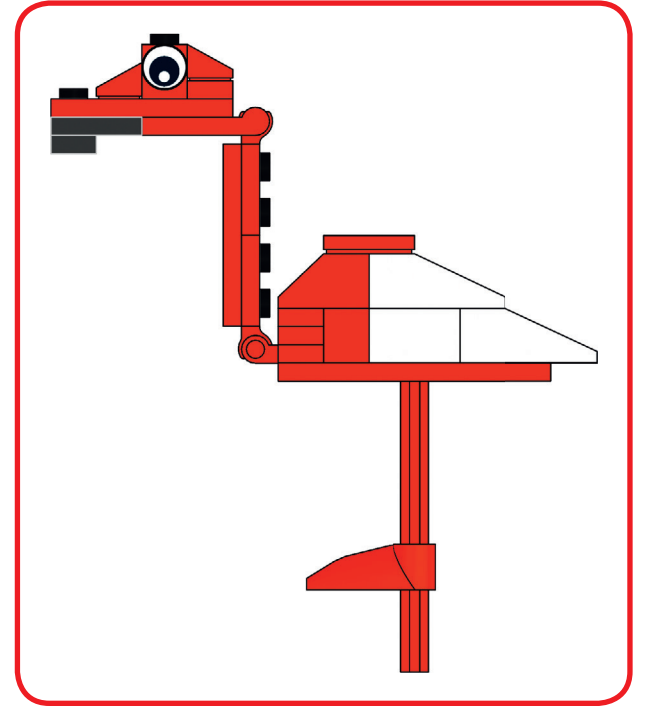
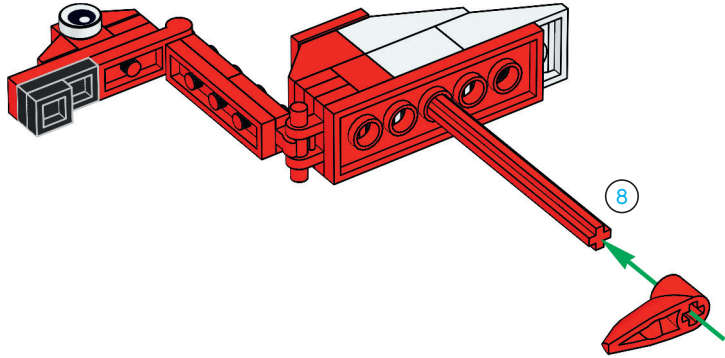

19

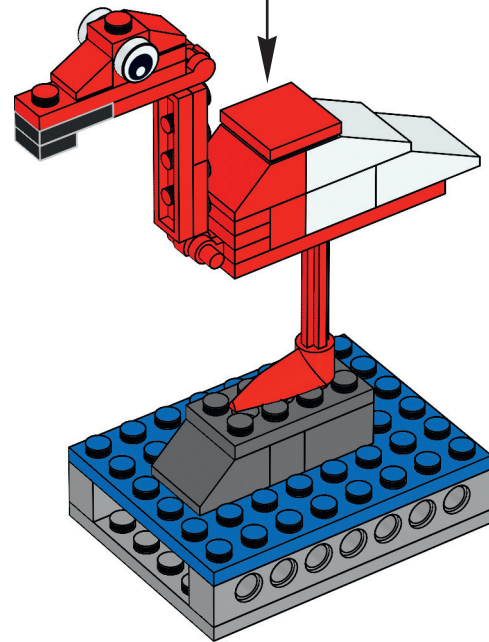

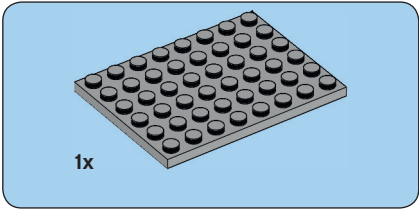
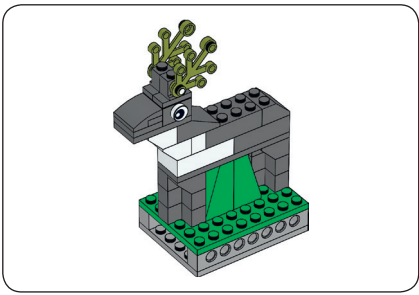

1

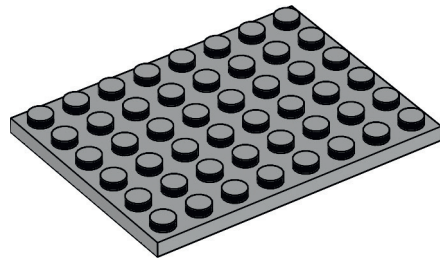

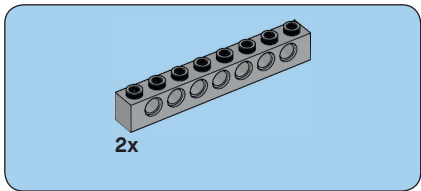

2

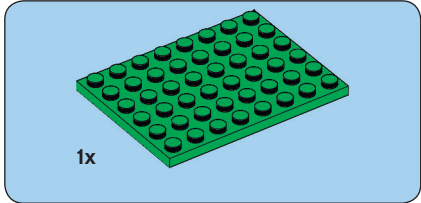
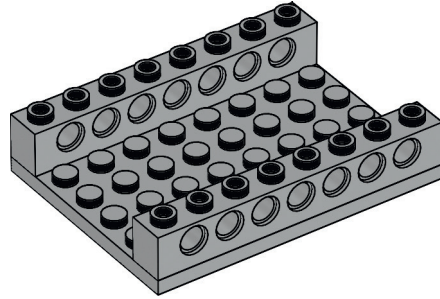

3

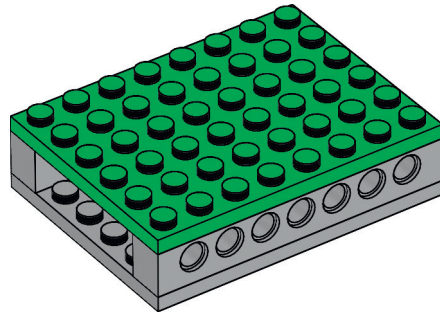

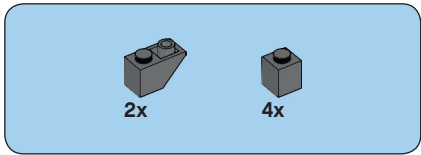

4

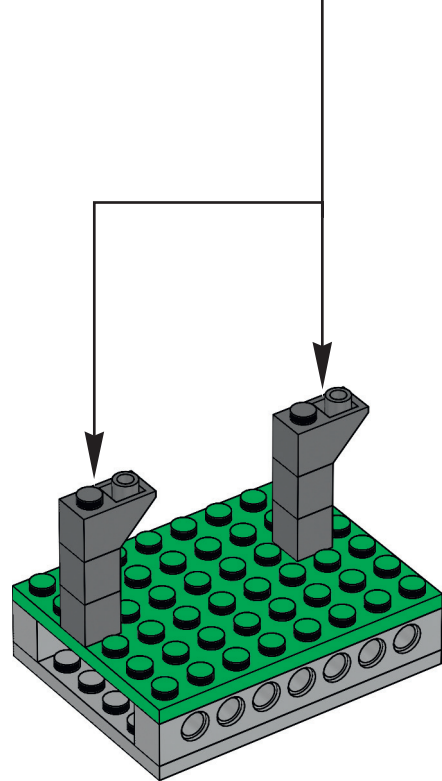
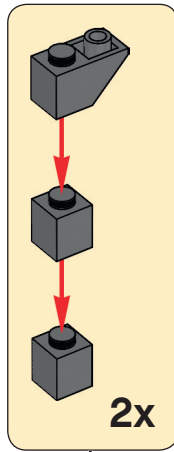

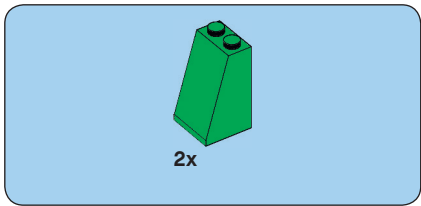

5

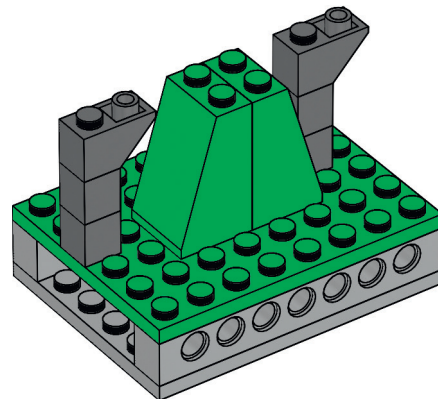

6

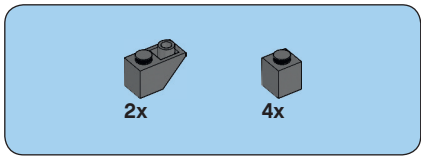

6

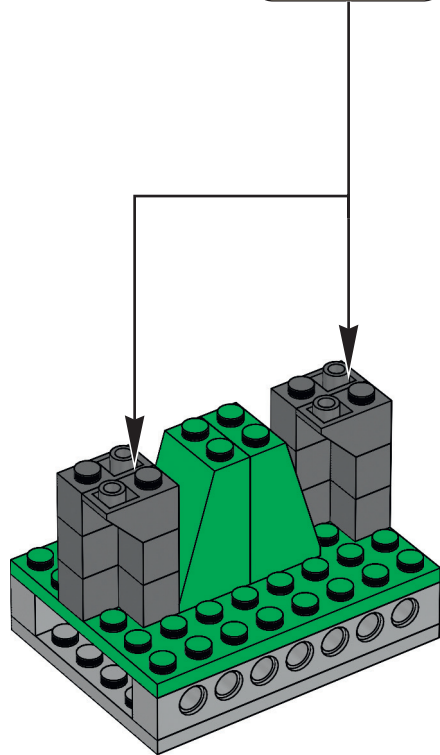
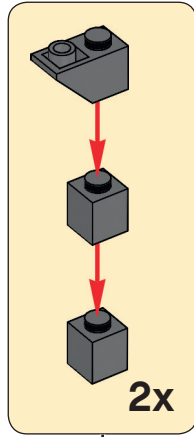

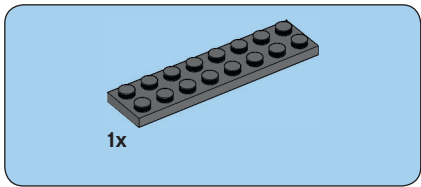

7

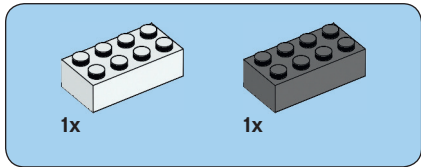
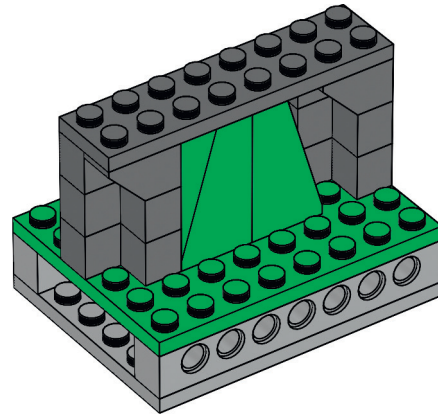

8

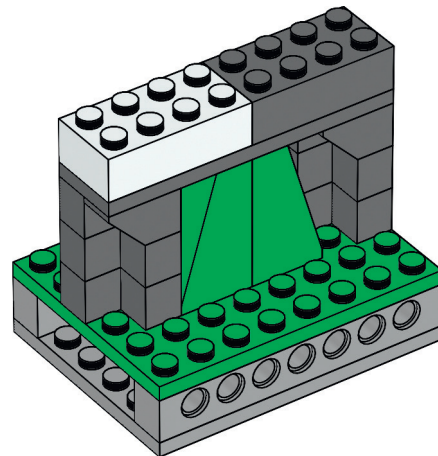

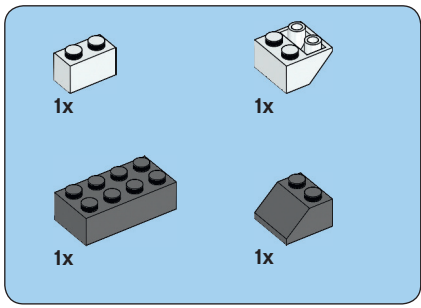

9

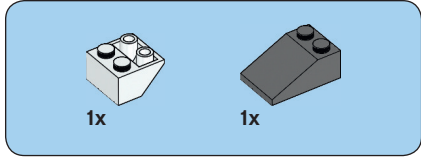
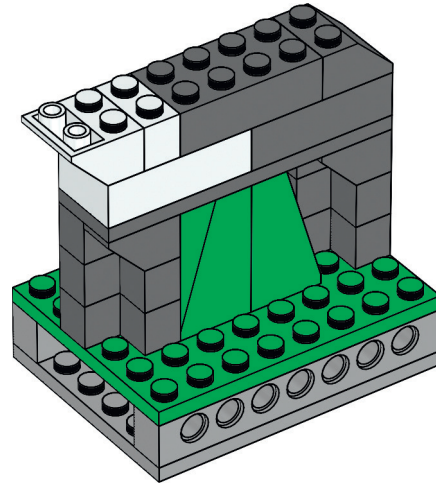

10

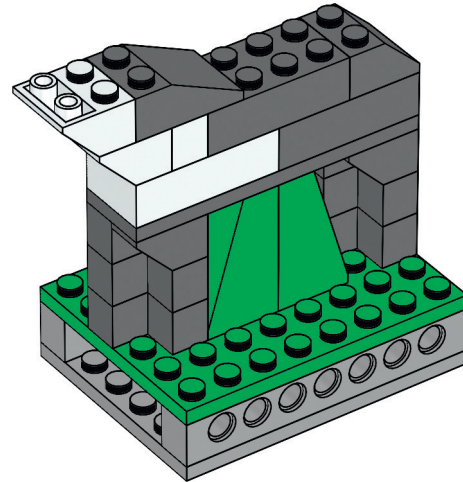

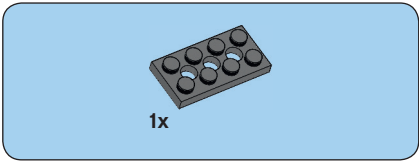
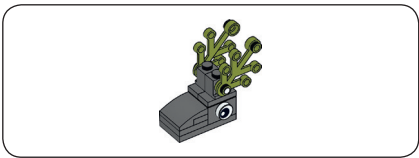

11

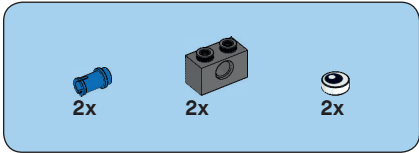

12

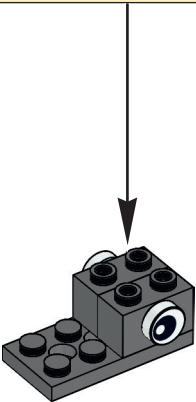
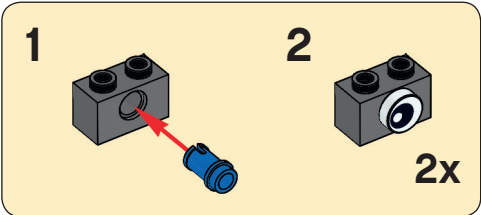

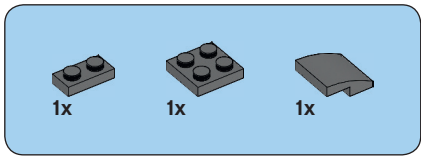

13

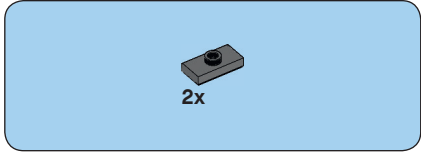
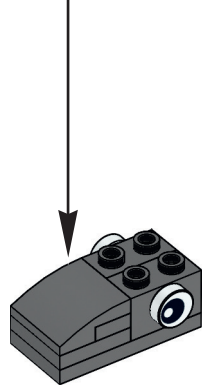
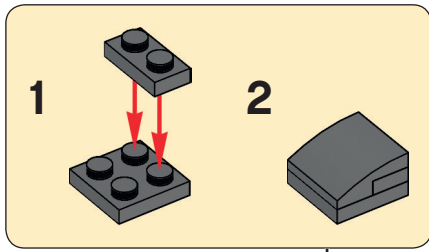

14

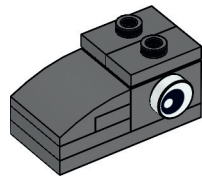



2x

15

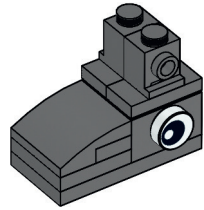

1x

16

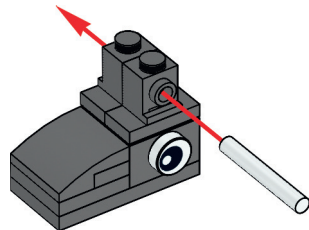

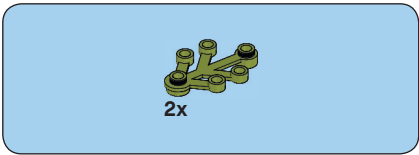

17

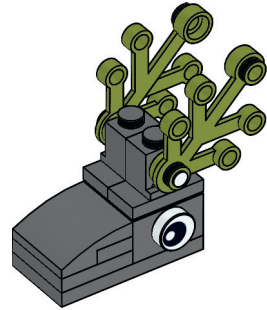

18

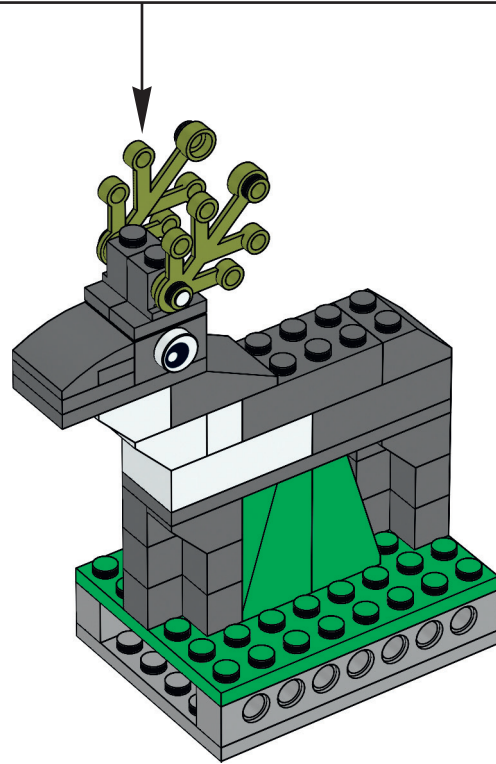

6

LEGO and the LEGO logo are trademarks of the/sont des marques de commerce du/son marcas registradas de LEGO Group. ©2016 The LEGO Group.

FIRST® and the FIRST® logo are trademarks of the United States Foundation for Inspiration and Recognition of Science and Technology (FIRST®).
FIRST® LEGO® League and ANIMAL ALLIES™ are jointly held trademarks of FIRST® and the LEGO Group. ©2016 FIRST and the LEGO Group.
FIRST® LEGO® League et ANIMAL ALLIES™ sont des marques déposées de FIRST® et du Groupe LEGO détenues en commun.
FIRST® LEGO® League y ANIMAL ALLIES™ son marcas comerciales en propiedad conjunta de FIRST® y The LEGO Group.