

2x

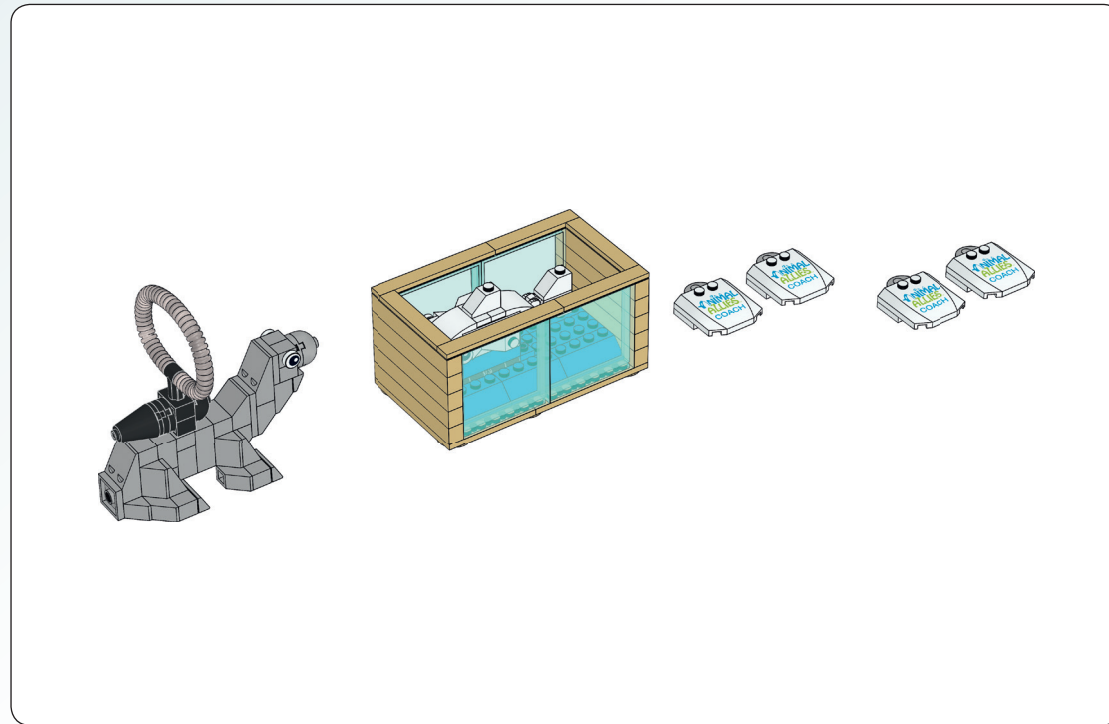

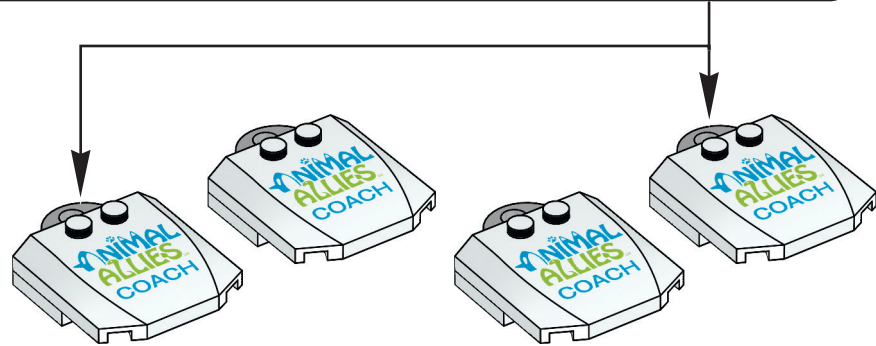

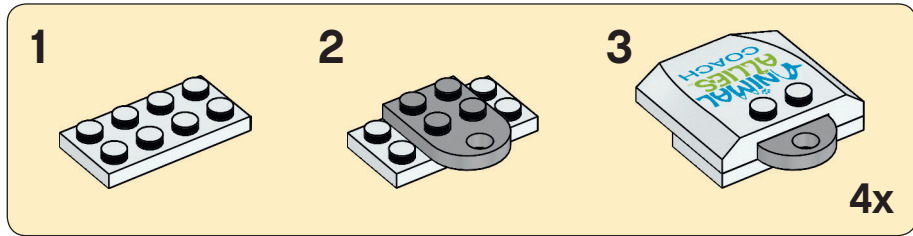
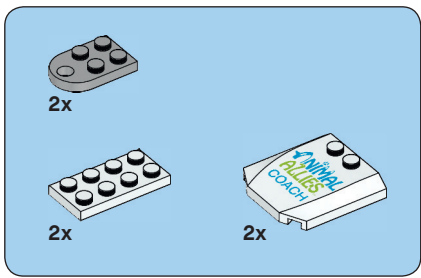
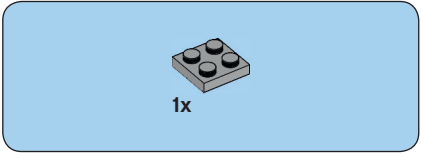
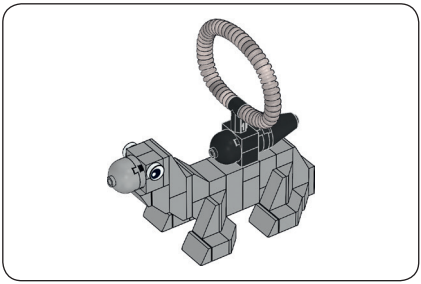

1

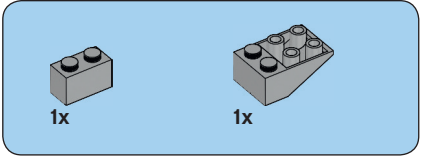
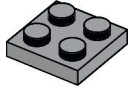

2

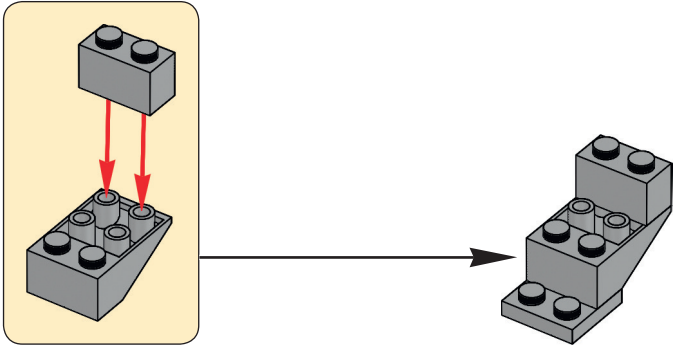

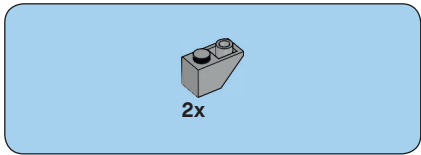

3

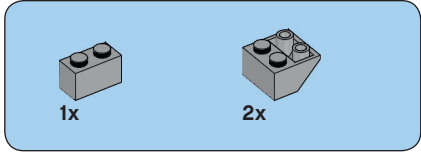
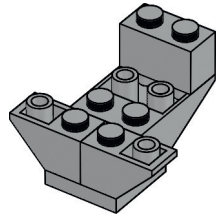

4

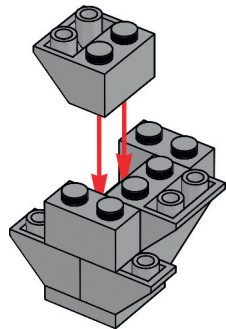

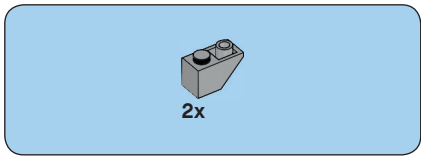

5

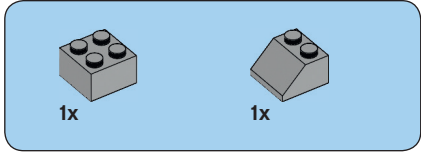
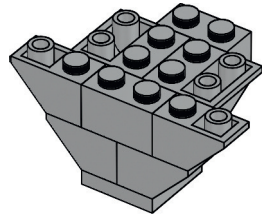

6

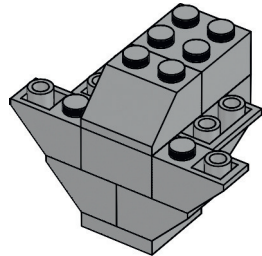

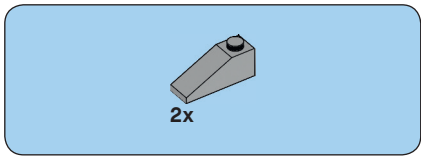

7

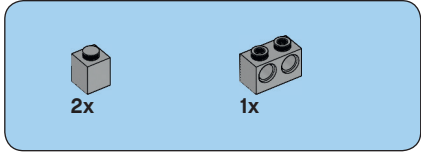
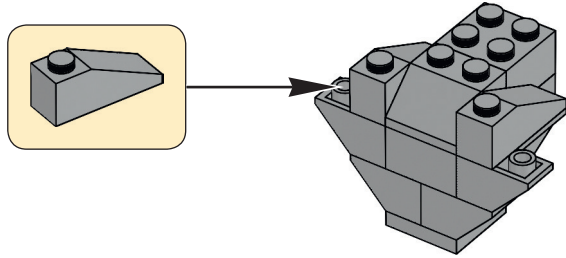

8

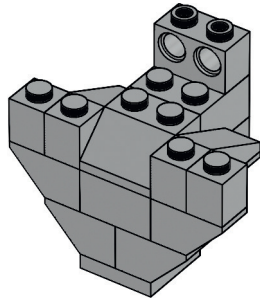

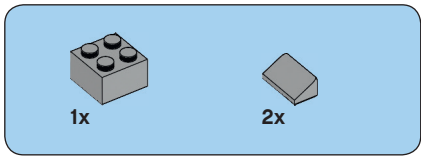

9

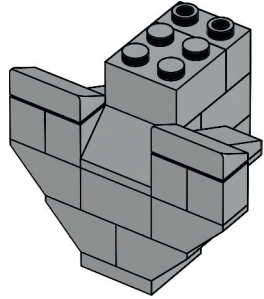

10

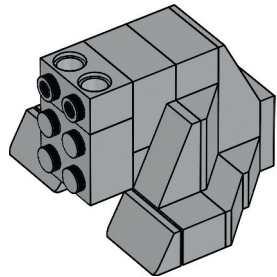

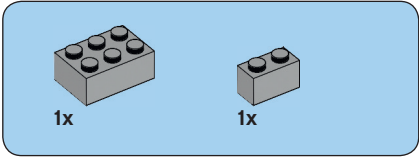
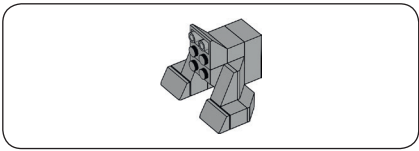

11

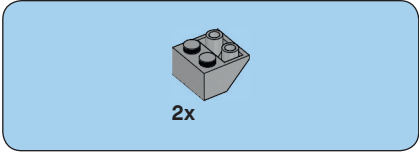
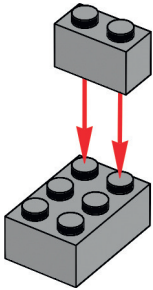

12

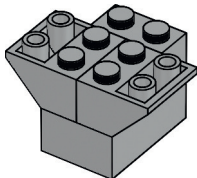

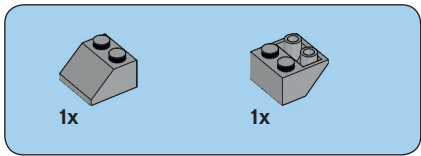

13

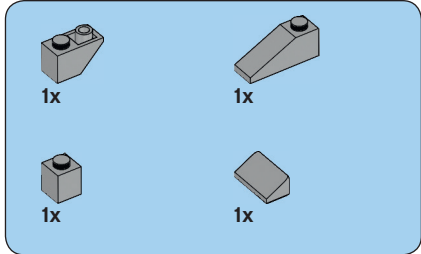
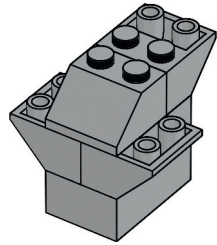

14

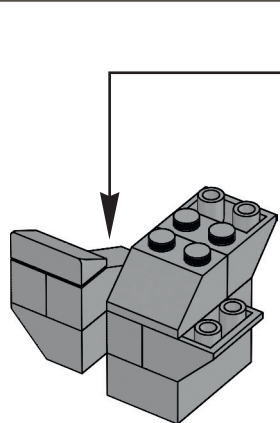
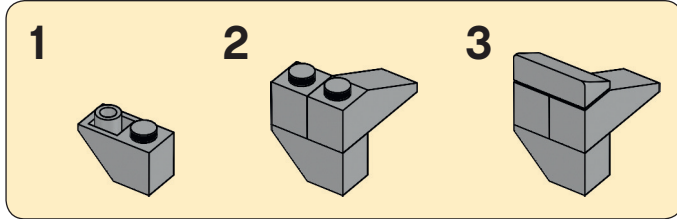

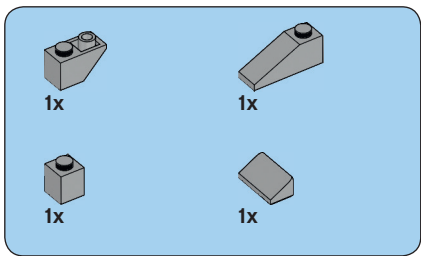

15

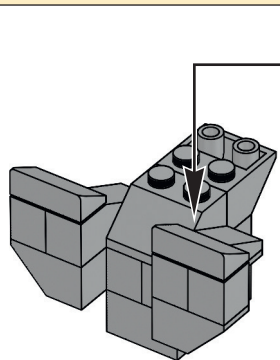
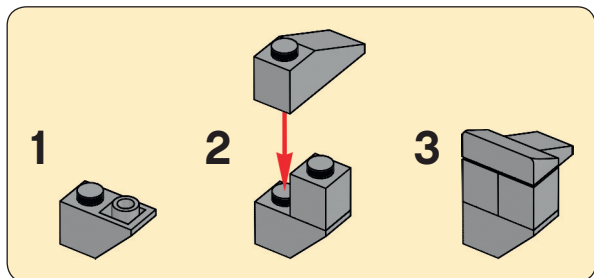

16

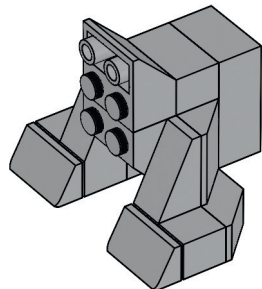

17

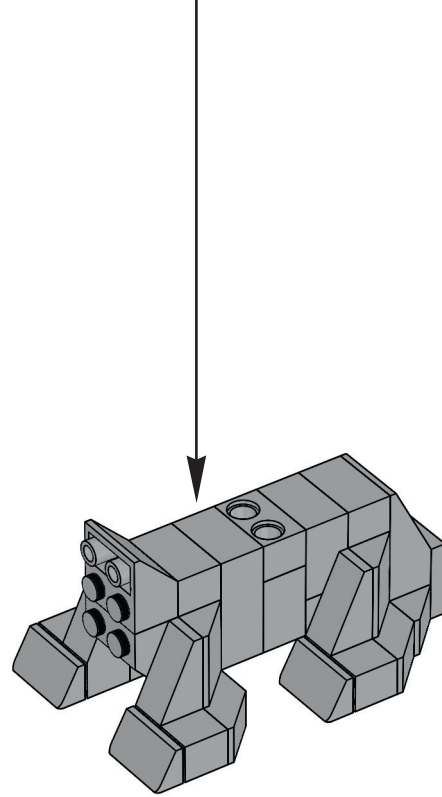

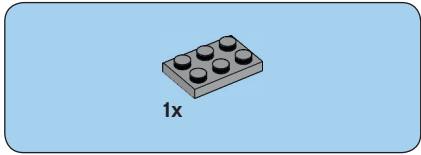
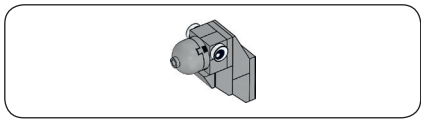

18

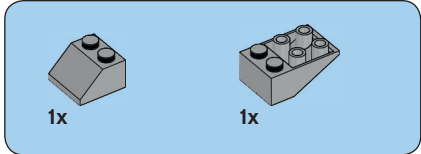
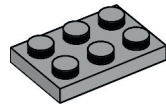

19

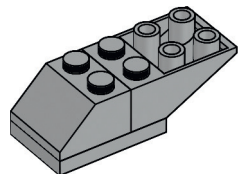

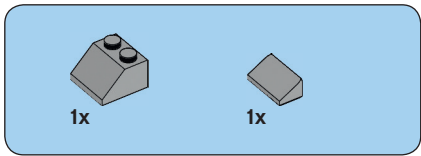

20

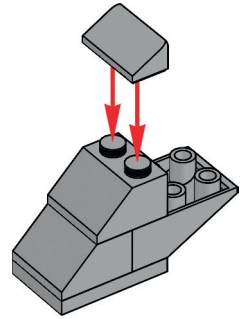

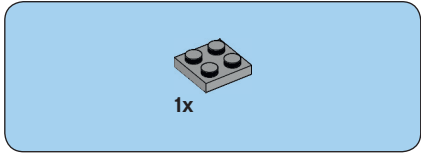
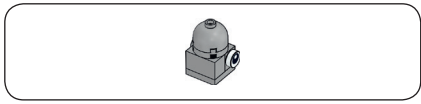

21

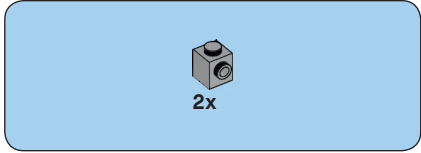
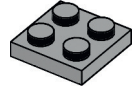

22

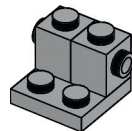
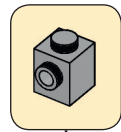

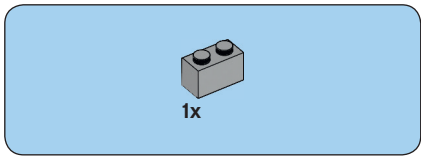

23

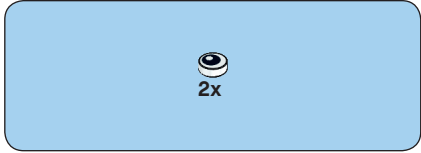
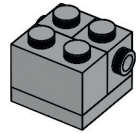

24

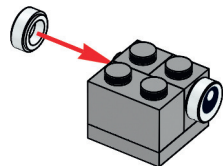



1x

25

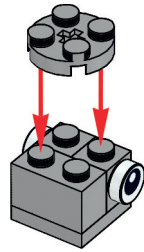

1x

26

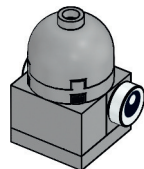

27

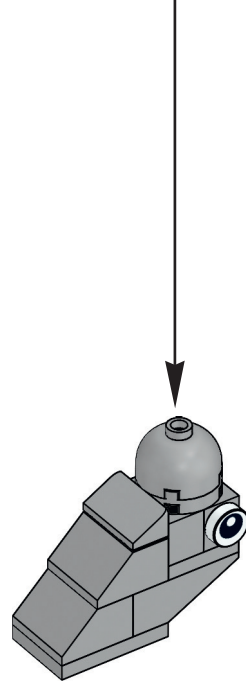

28

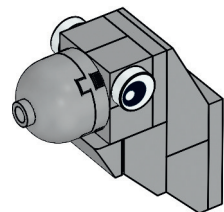

29

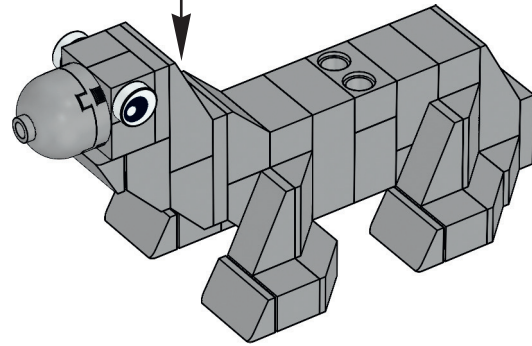

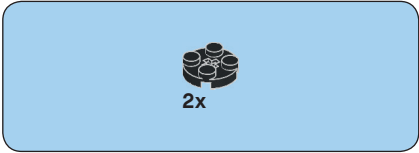
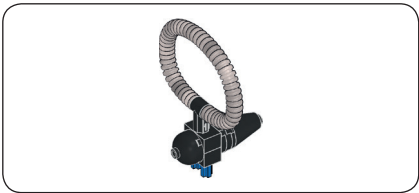

30

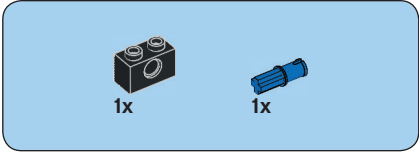
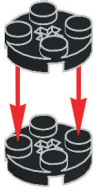

31

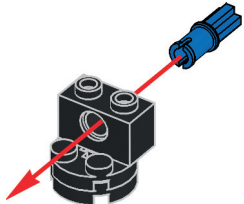



1x

32

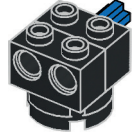

2x

33

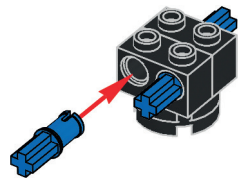

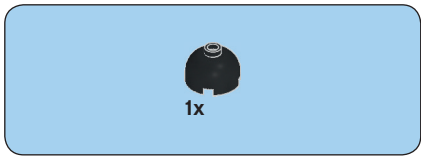

34

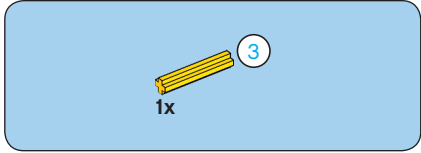
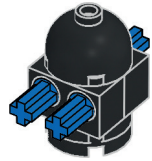

35

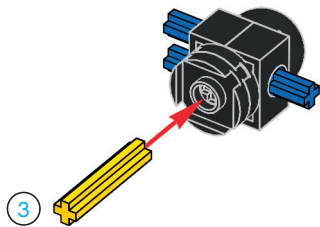



1x

36

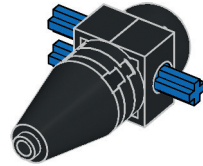

1x



1x

37

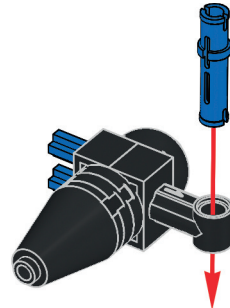

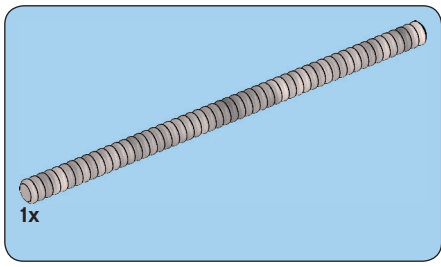

38

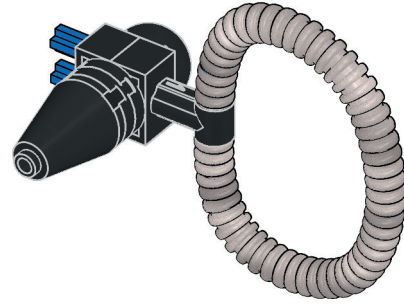

39

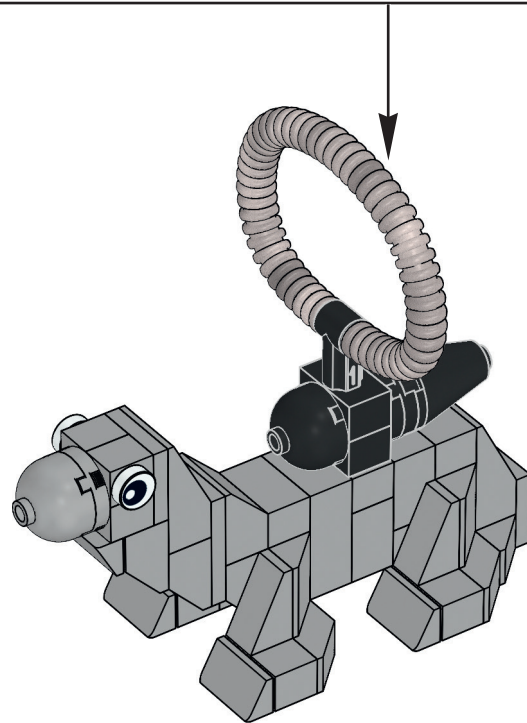

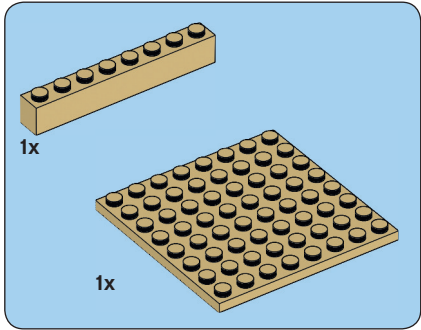
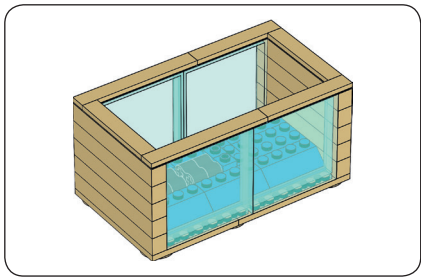

1

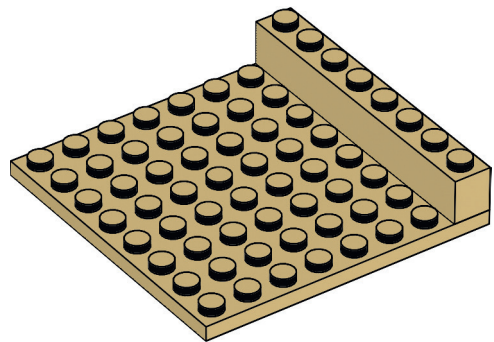

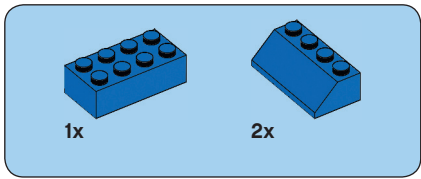

2

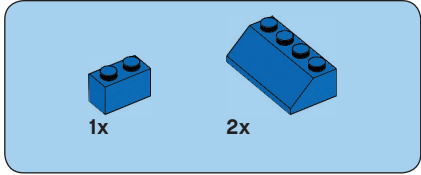
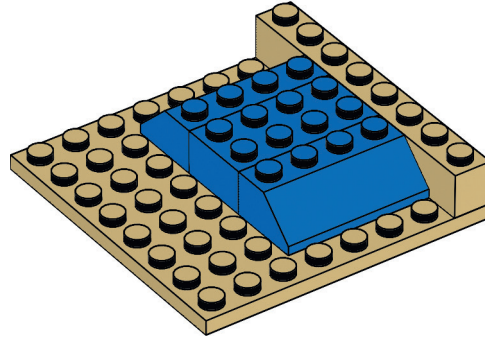

3

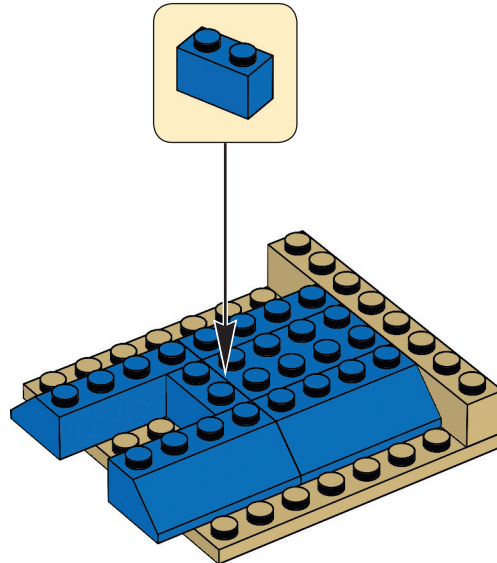

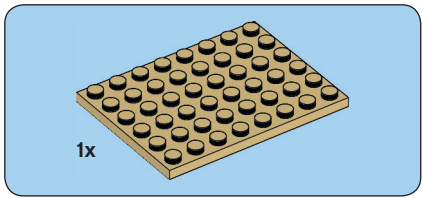

4

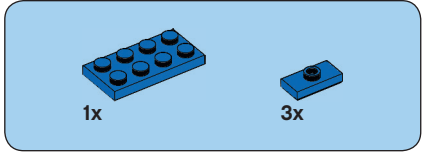
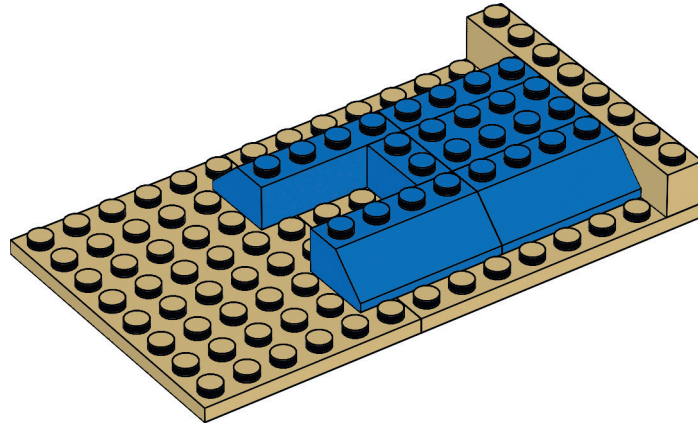

5

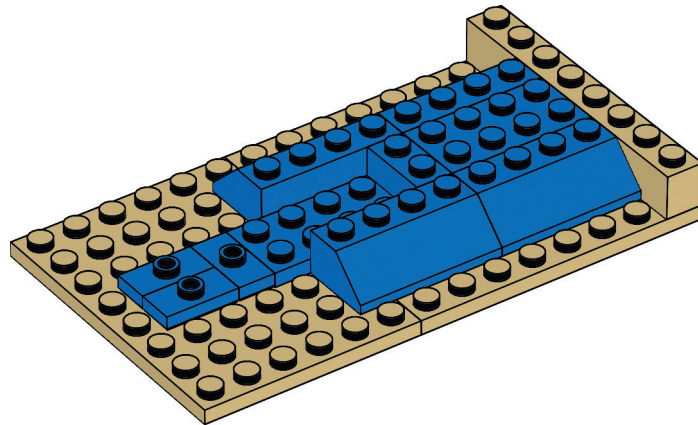

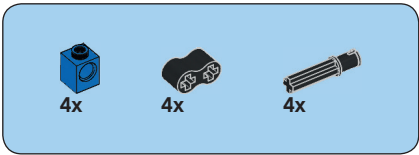

6

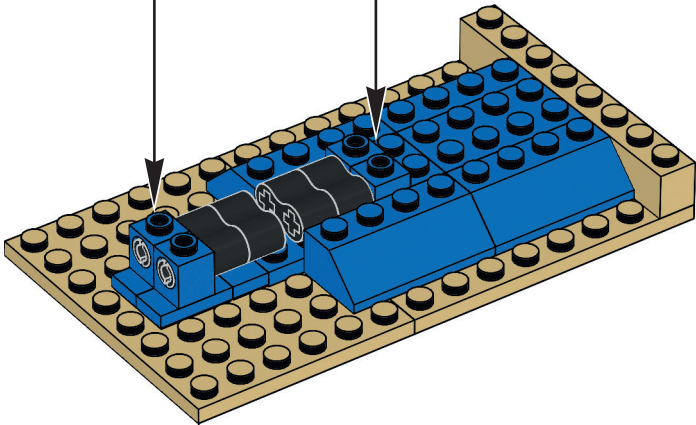
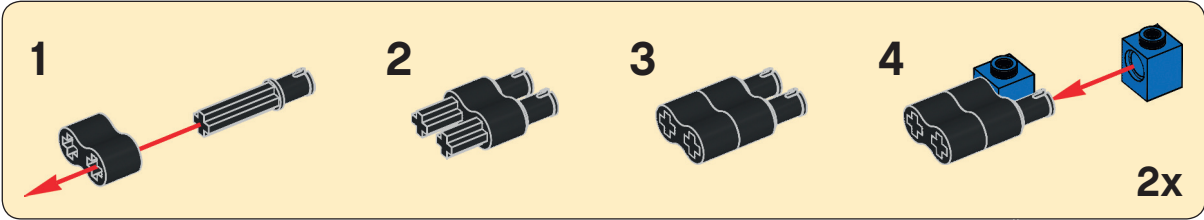

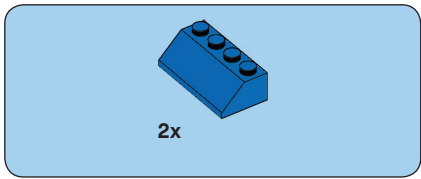

7

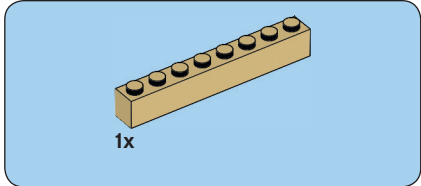
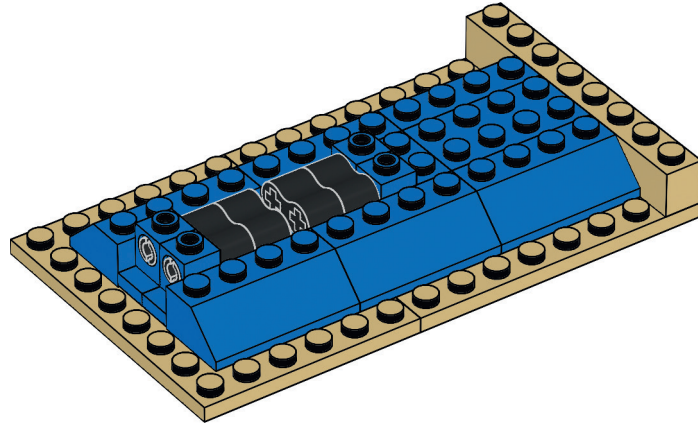

8

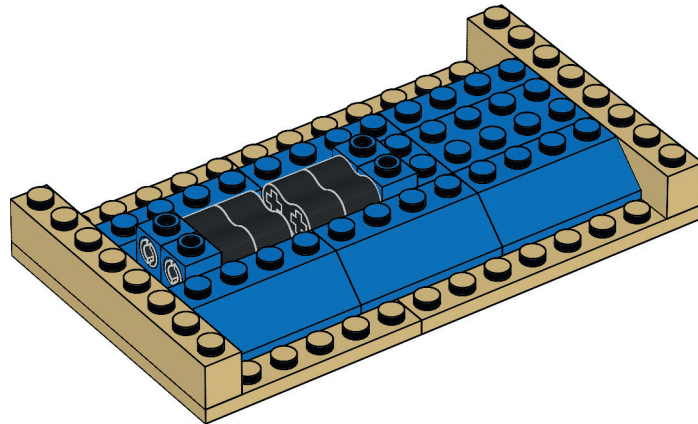

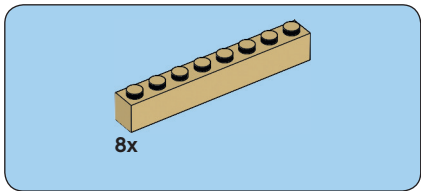

9

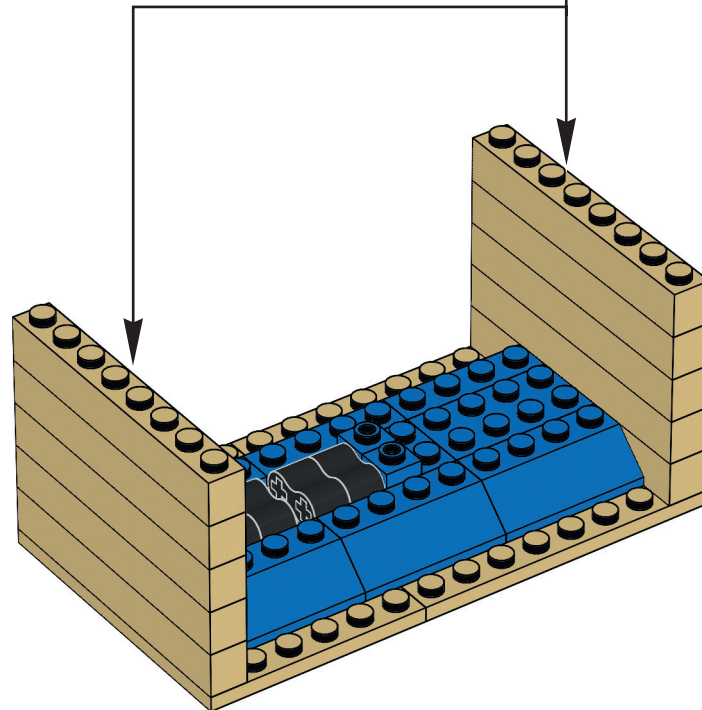
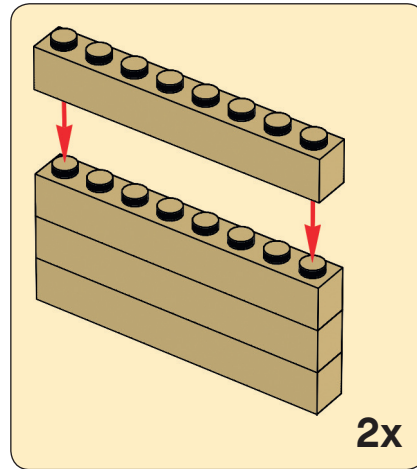

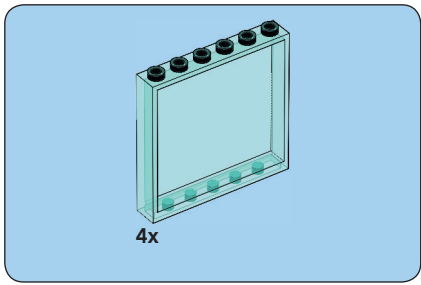

10

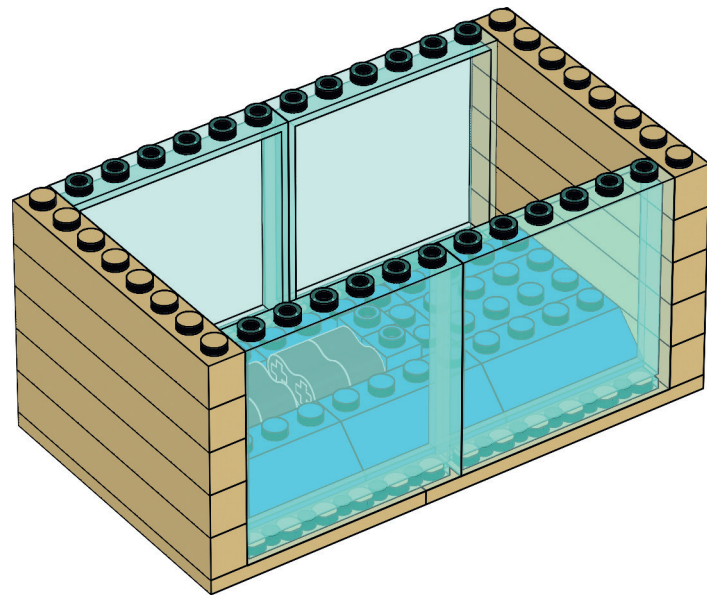

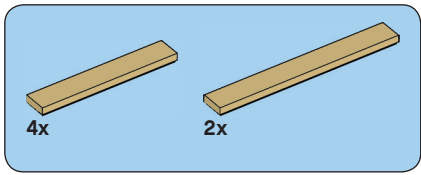

11

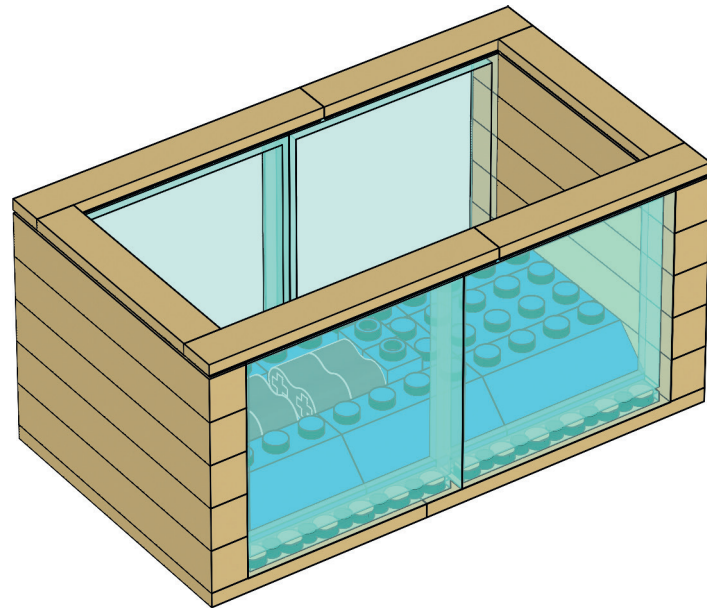



12

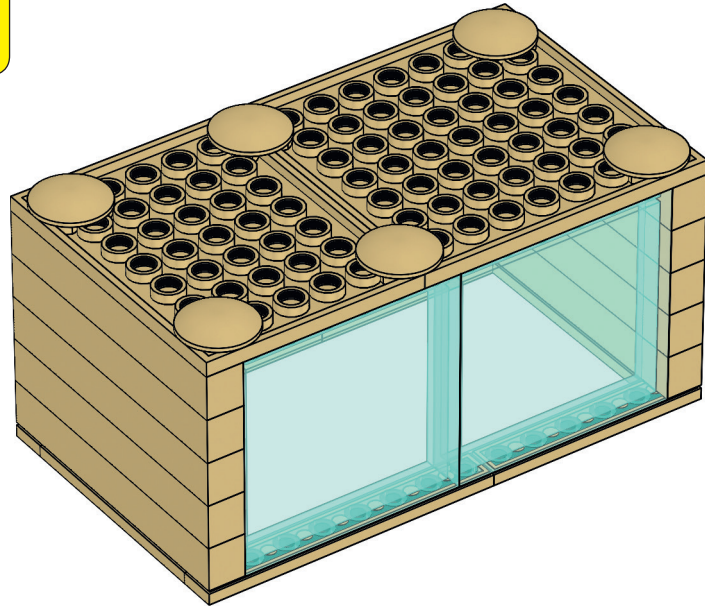

13

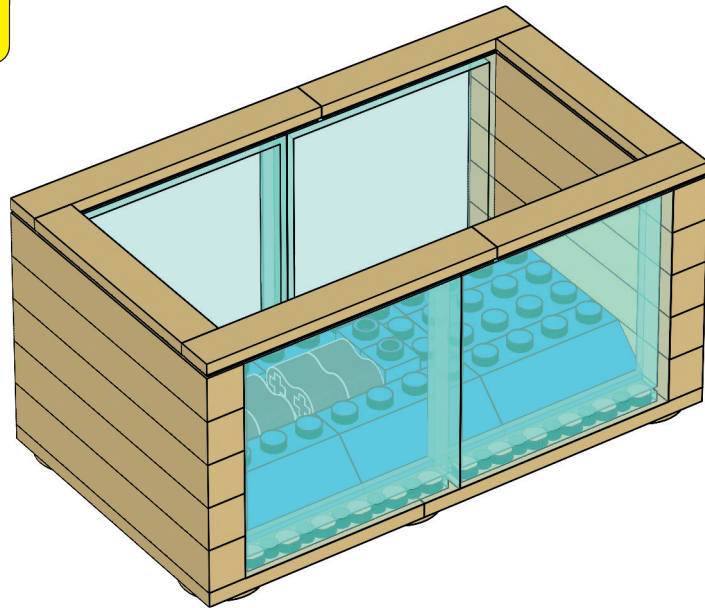
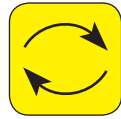

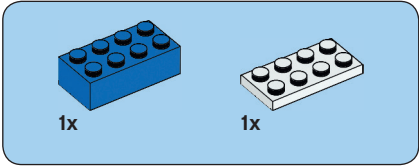
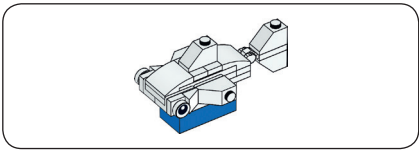

1

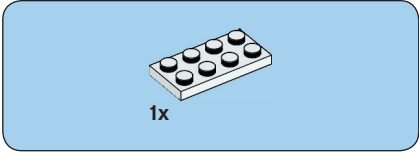
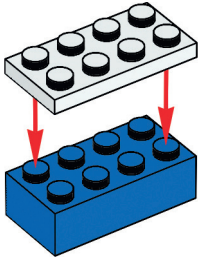

2

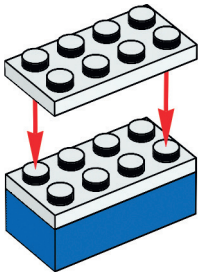

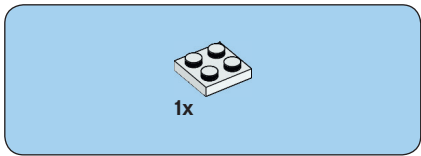

3

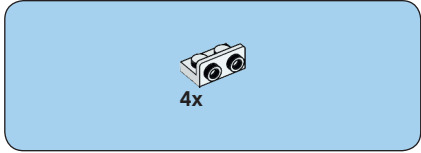
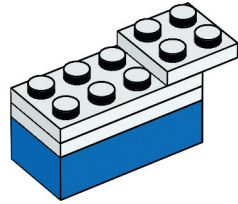

4

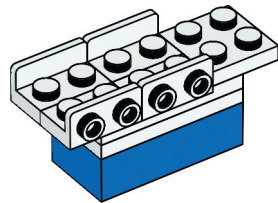

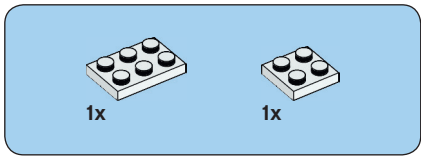

5

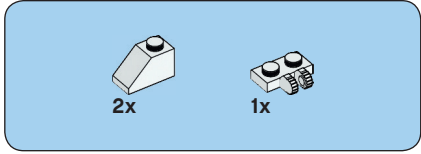
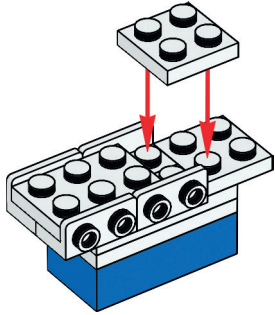

6

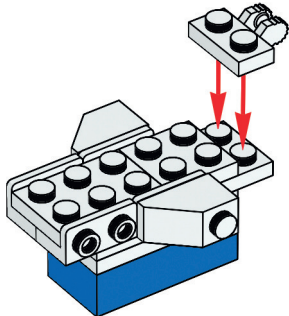

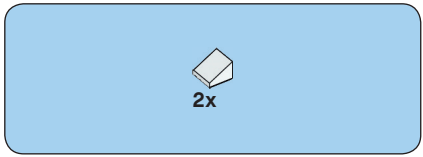

7

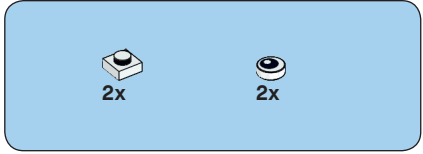
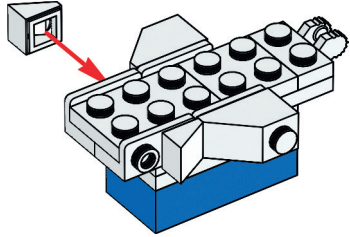

8

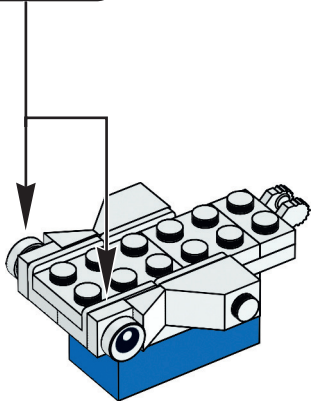
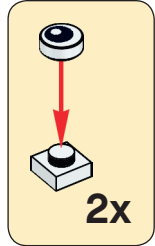

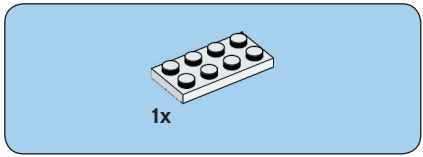

9

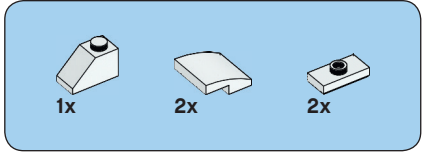
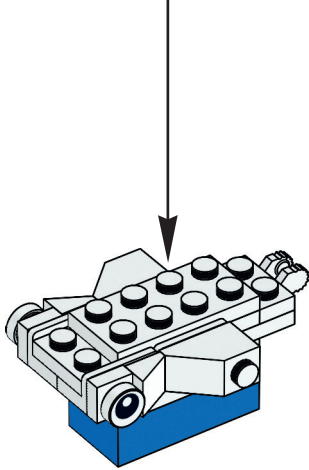
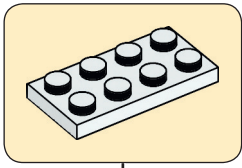

10

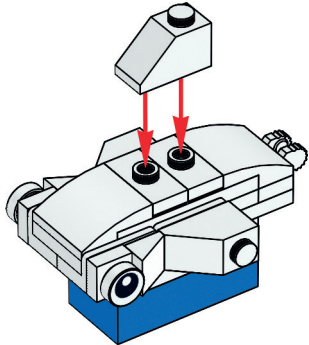

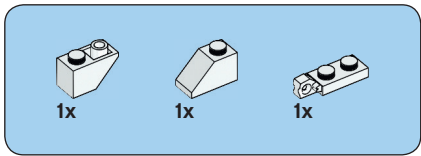

11

