

1x

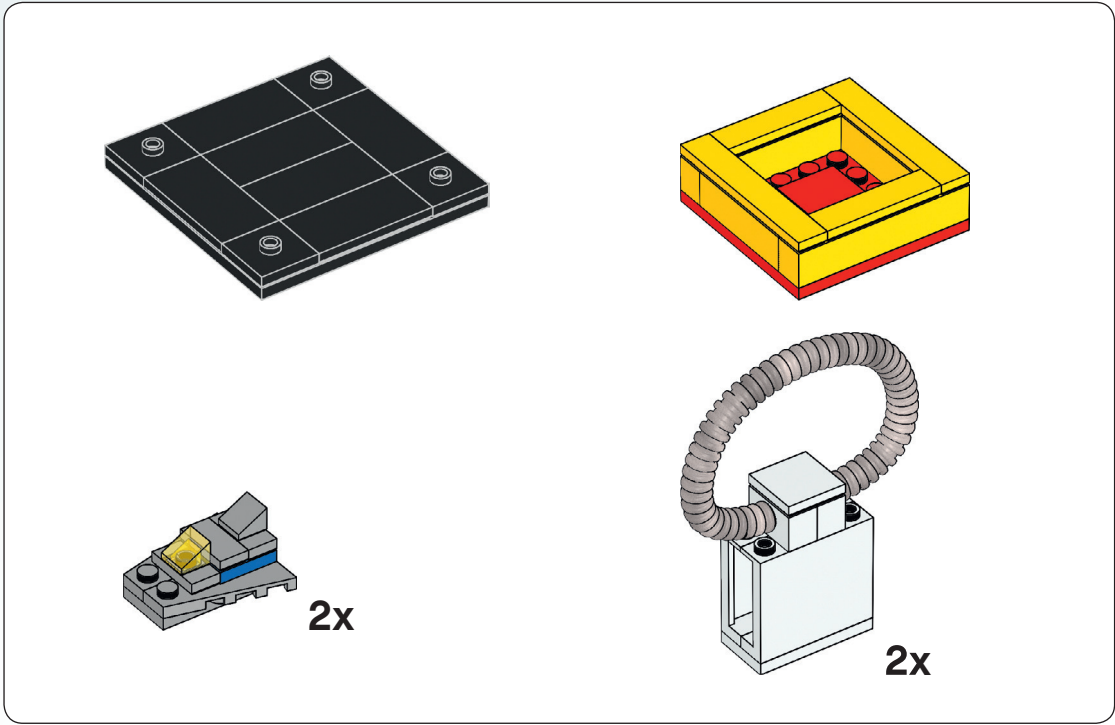

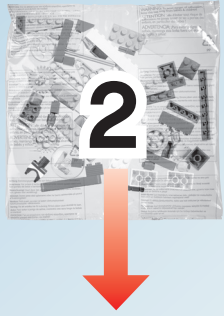

1

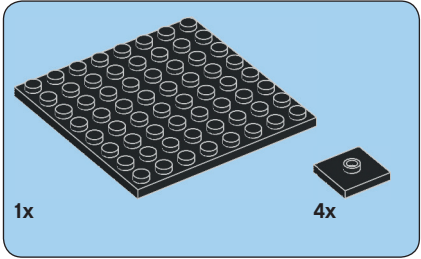
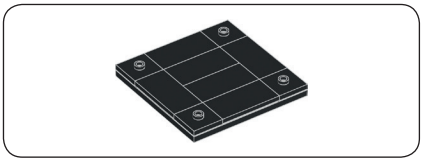
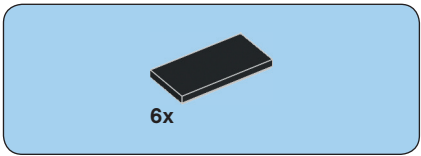
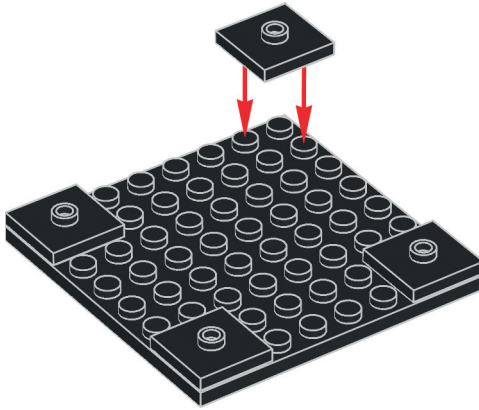

2

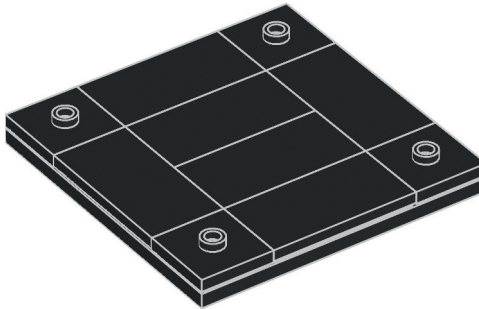

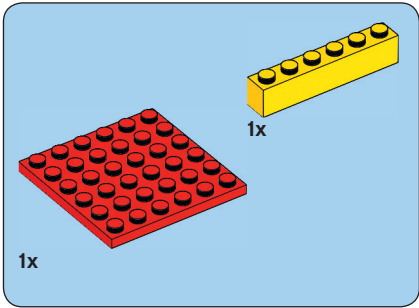
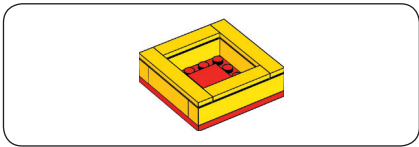

1

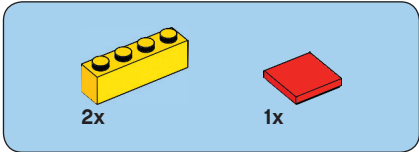
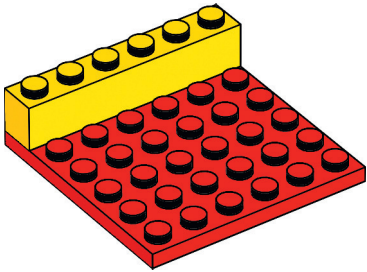

2

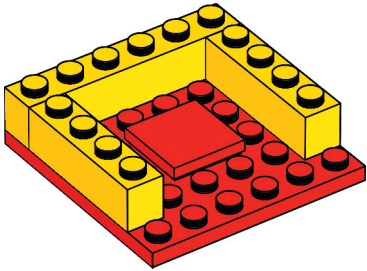

2

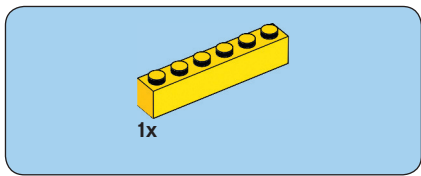

3

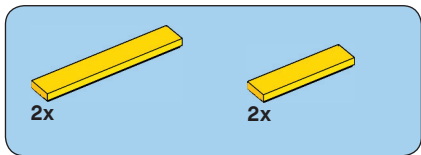
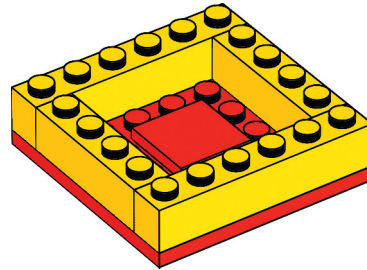

4

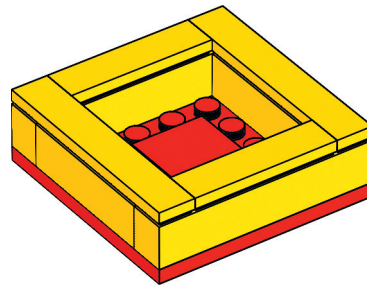

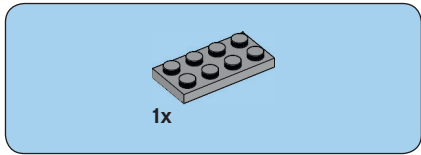
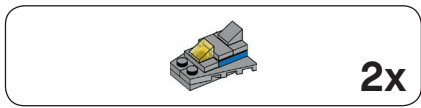

1

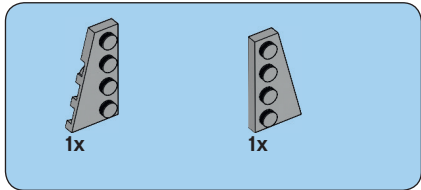
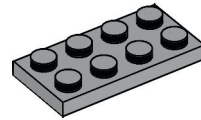

2

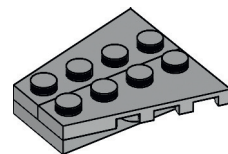

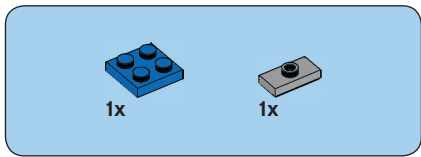

3

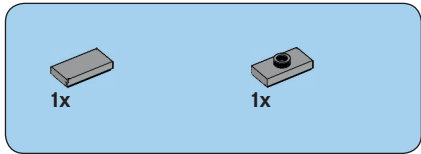
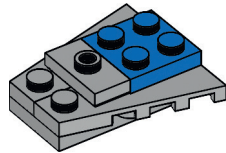

4

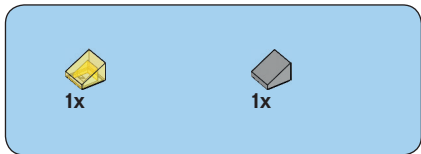
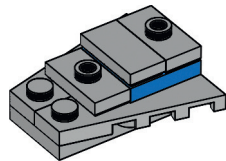

5

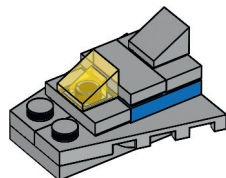

2x

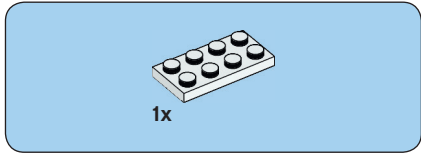
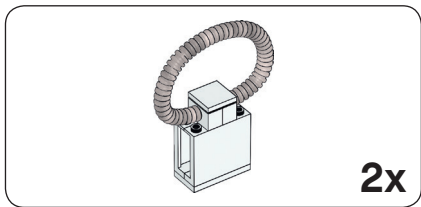

1

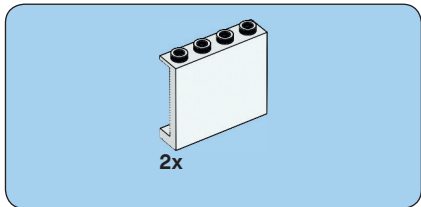

2

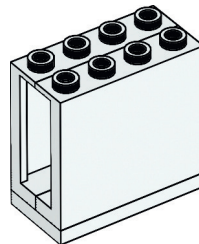

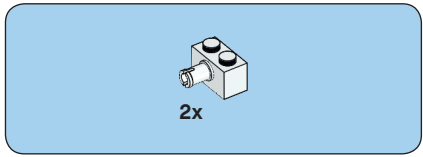

3

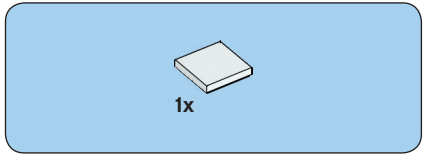
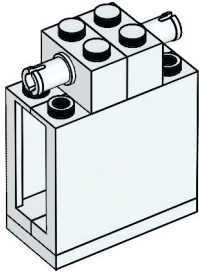

4

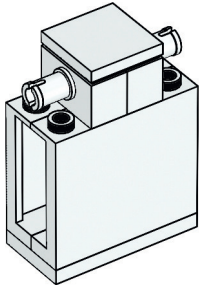



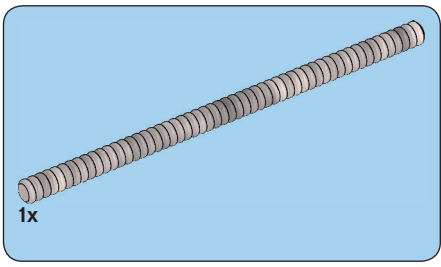

5

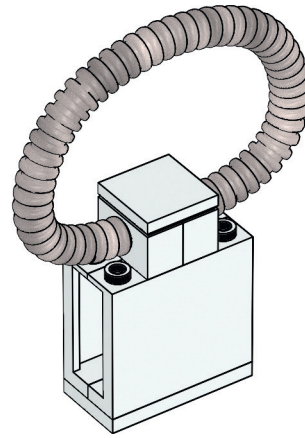

2x

2